



SK-G01 Series

*Wet Type Solenoid Operated
Directional Control Valve With
Deutsch Connector*



Features

- High pressure, large capacity with minimal pressure loss
- High dust and water resistance (JIS C 0920 IP67)
- High vibration proof (JIS D 1601 3 D Grade 90 Division 400)
- Shockless type available (Option: F)
- Diode built in coil available (Option: G)
- Low switching noise and very long life

Specifications

Model Number		SK-G01			
		Standard Type		Shockless Type	
JIS Symbol	Operation	Maximum Flow Rate L/min(gpm)	Maximum Working Pressure MPa(psi)	Maximum Flow Rate L/min(gpm)	Maximum Working Pressure MPa(psi)
	A3X	80 (21.1)	35 (5075)	50.0 (13.2)	25 (3625)
	H3X				
	E3X				
	C5				
	C6				
	C4				
	C7Y	50.0 (13.2)		40 (10.6)	

Maximum Working Pressure MPa(psi) P, A, B ports	Standard Type	35 (5075)
	Shockless Type	25 (3625)
Maximum Allowable Back Pressure MPa(psi) T port	Standard Type	21 (3045)
	Shockless Type	
Switches/min	Standard Type	120
	Shockless Type	
Option	Shockless	F
	Surgeless (Diode built in coil)	G
Weight kg (lbs)	Double solenoid	2.0 (4.41)
	Single solenoid	1.5 (3.31)
Operating Environment	Dust Resistance/Water Resistance Rank	JIS C 0920 IP67
	Vibration Proof	JIS D 1601 3 D Grade 90 Division 400
	Ambient Temperature	-30~+50°C (-22~+122°F)
Operating Fluid	Temperature Range	-25~+80°C (-13~+176°F)
	Viscosity Range	15~300mm ² /s(cSt)
	Filtration	25 μm or less
Mounting Bolts	Size x Length	M5x45 or #10x44.5, four bolts
	Tightening Torque	Hexagon socket head bolts of strength 12T 5~7N•m (3.69~5.16lbf•ft)

Note) 1. Maximum operating pressure depends on the valve type. For details, see "Permissible pressure-flow rate values."

- A protective cover is recommended to avoid splashing the valve directly.
- For mounting bolts, use 12T or equivalent.
- Mounting bolts are not included.

Model Code

S K - G 0 1 - A 3 X - D G T - D 1 - 5 5 0 3 H

- Design number
- Power supply D1=DC12V D2=DC24V
- Deutsch connector
- Auxiliary symbol (Can be combined in alphabetic sequence)
F: Shockless type G: Surgeless type (Diode built in coil)

Transition Flow Path (A3X, H3X, E3X and C7Y)

X	Y
Closed	Semi-open

Center position

3	4	5	6	7

Operation method

A	H	C	E
Spring offset type		Spring Center type	

Nominal diameter

Mounting method G: Gasket type

Wet type solenoid operated directional control valve

Solenoid Assembly Specifications

Solenoid Type	Power Supply Type	Voltage (V)	Solenoid Coil Model Number	Holding Current (A)	Holding Power (W)	Allowable Voltage Range (V)
DC	D1	DC12	EKB64-DT-D1-5503	2.5	30	10.8 - 13.2
			EKB64-DGT-D1-5503(Surgeless type)			
	D2	DC24	EKB64-DT-D2-5503	1.25	30	21.6 - 26.4
			EKB64-DGT-D2-5503(Surgeless type)			

Permissible Pressure-Flow Rate Values

•Standard type

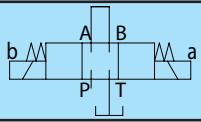
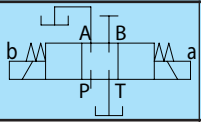
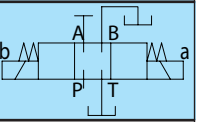
Type	Standard Type		
Operation Example			
Operation Symbol			
A3X	B	I	I
H3X	B	I	I
E3X	A	H	H
C4	D	D	D
C5	A	G	G
C6	C	G	G
C7Y	E	I	I

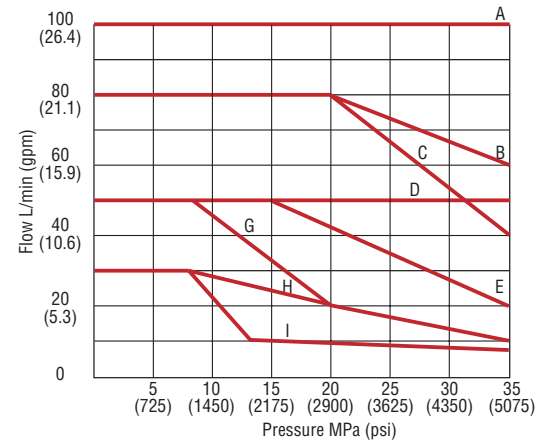

•Shockless type

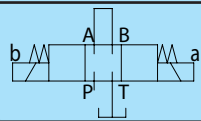
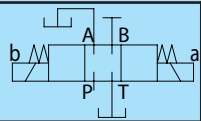
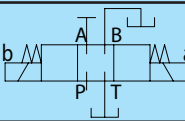
Type	Shockless Type		
Operation Example			
Operation Symbol			
A3X	J	N	N
H3X	J	N	N
E3X	J	M	M
C4	J	J	J
C5	J	N	N
C6	K	N	N
C7Y	L	N	N

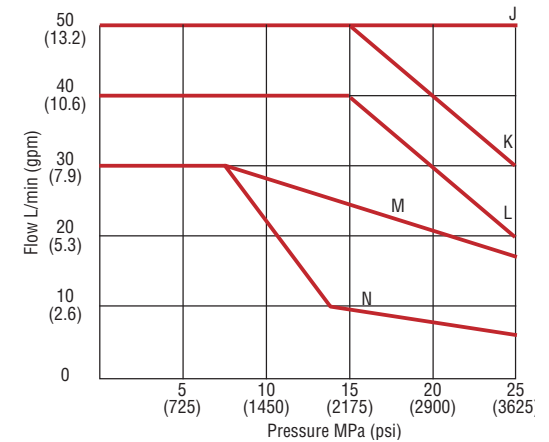

Switching Response Time

Model Number	Response Time (sec.)		Measurement Conditions
	Solenoid ON	Solenoid OFF	
SK-G01-**-DT-D*-5503H	0.03 to 0.04	0.02 to 0.04	14MPa (2030psi) 30L/min (7.9gpm)
SK-G01-**-DGT-D*-5503H	0.03 to 0.04	0.07 to 0.10	
SK-G01-**-DFGT-D*-5503H	0.07 to 0.10	0.10 to 0.15	

Note) The switching response time changes slightly with operating conditions. (Pressure, flow rate, viscosity, etc.)

Dimensional Drawings

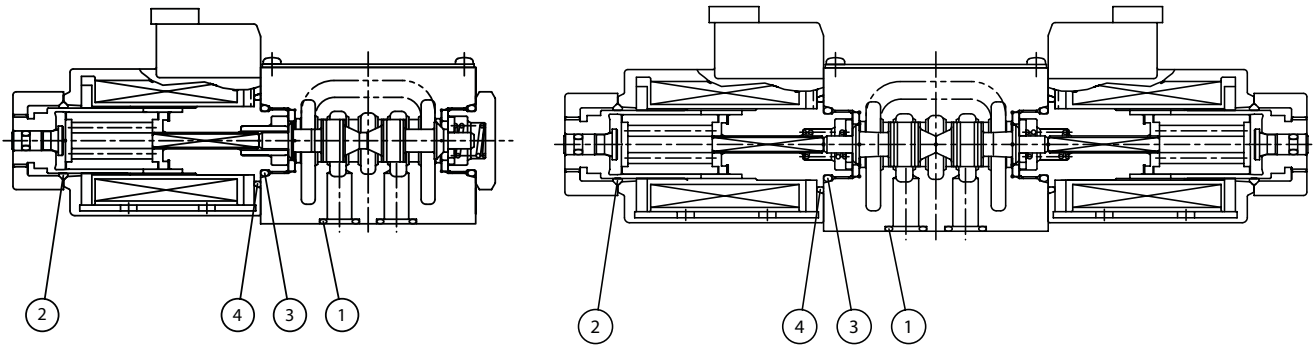
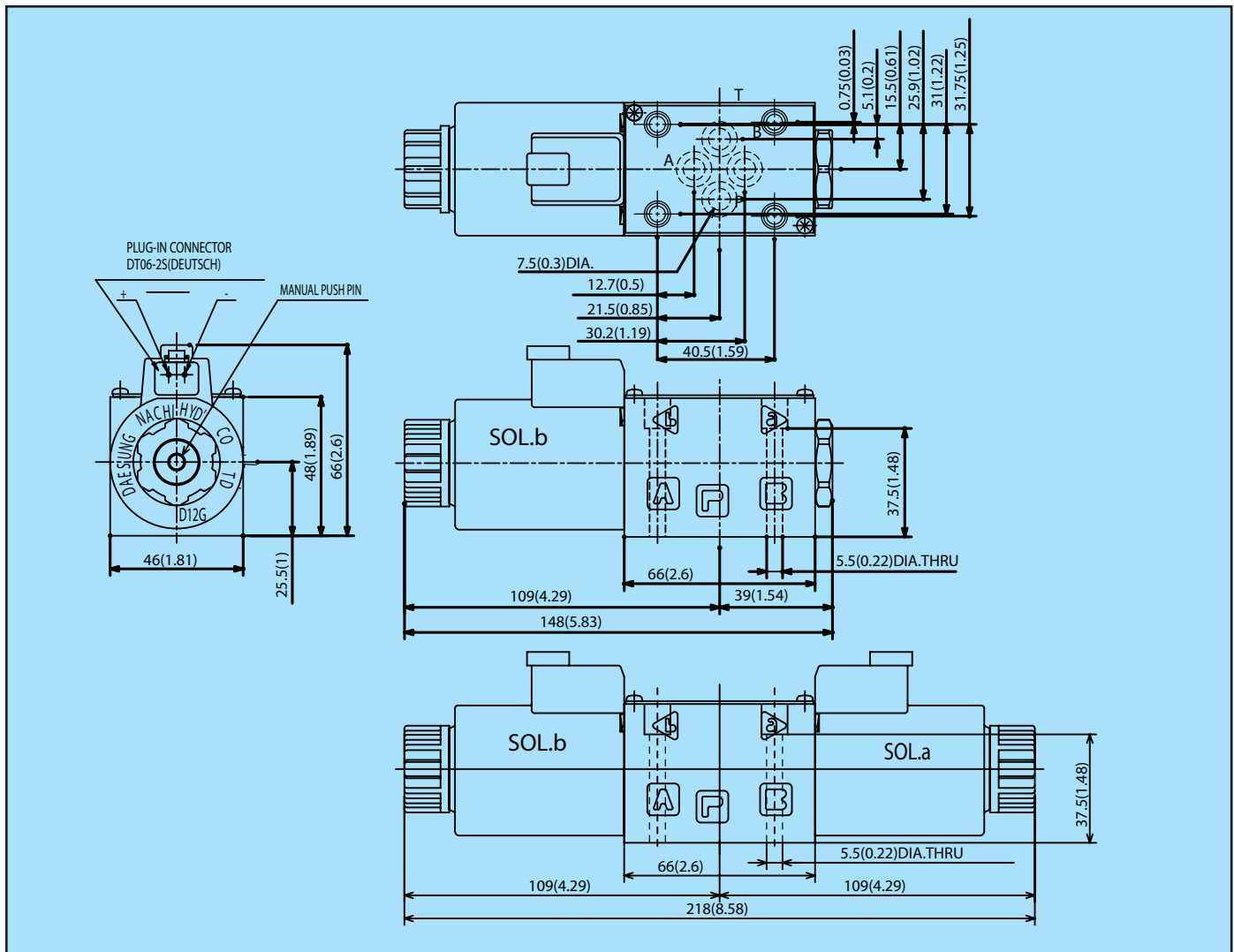

Sealing Parts

Part No.	Part Name	Part No.	Quantity	
			Single Solenoid	Double Solenoid
1	O-ring	AS568-012(Hs90)	4	4
2	O-ring	1A-P20	1	2
3	O-ring	1B-P18	2	2
4	O-ring	S-25	1	2

Note) 1A and 1B are JIS Standard B 2401, while AS568 is SAE Standard.

NACHI

NACHI AMERICA INC.

17500 23 Mile Road, Macomb, MI 48044

Tel. (800)622-4410 Fax. (586)226-5289

Email: hydraulics@nachi-america.com

www.nachi-hydraulics.com