

Load Response Electro-Hydraulic Proportional Relief and Flow Control Valve

.26 to 132 gpm
3625 psi

Features

The load sensing function of this meter in flow control valve makes it possible to control pump discharge pressure automatically in accordance with the size of the load

pressure. Using this valve suppresses wasteful pump pressure rises and makes it possible to configure an energy-efficient circuit.

- Handling
 - 1 In order to ensure stable control, loosen the air vent and bleed air from the valve before starting operation.
 - 2 Manual Adjusting Screw
For the initial adjustment or when there is no input current to the valve due to an electrical problem or some other reason, pressure or flow rate can be increased by rotating the manual adjustment screw clockwise (rightward). Normally, this adjusting screw should be returned completely to its original position and secured with the lock nut.
 - 3 Drain Port
Minimum control pressure is increased by drain port back pressure, so be sure to connect the drain port directly to the fluid tank at a point that is below the oil surface.
 - 4 Safety Valve Setting Pressure
For a safety valve without an electro-hydraulic proportional pilot relief valve, safety valve pressure is set to minimum pressure (507 psi). In the case of a safety valve with an electrohydraulic proportional pilot relief valve, the safety valve setting pressure is set to the minimum adjustment pressure plus 217 psi. When actually using the valve, adjust in accordance with hydraulic circuit pressure.
 - 5 Minimum Relief Flow Rate During Pressure Control
Setting pressure can become unstable when the relief flow rate to the valve's T port is small. Because of this, use a relief flow rate of at least 2.6 gpm with a nominal diameter of .1", and a relief flow rate of at least 2.6 gpm with a nominal diameter of .39".
 - 6 Valve Mounting Orientation
When an electro-hydraulic proportional pilot relief valve main valve is mounted on a vertical surface with the pilot relief valve part facing downwards make it difficult to bleed air from the pilot relief valve. Because of this, you should not use this type of mounting orientation.
 - 7 Bundled Accessories (Valve Mounting Bolts)

Specifications

Item	Model No.	ESR-G03-125 (R*)-12	ESR-G06-250 (R*)-12	ESR-G10-500 R*-11
Maximum Operating Pressure psi		3625	3625	3625
Rated Flow Rate l/min (gpm)		125 (33)	250 (66)	500 (132)
Flow Rate Control System	Flow Rate Control Range gpm	.5 to 33	1.3 to 66	3.9 to 132
	Valve Differential Pressure psi	72 (Note1)	101 (Note1)	130 (Note1)
	Hysteresis %	3 max. (Note 2)	3 max. (Note 2)	3 max. (Note 2)
	Repeatability %	1	1	1
	Rated Current mA	800	800	800
	Coil Resistance Ω	20 (68°F)	20 (68°F)	20 (68°F)
Pressure Control System (Note 3)	Pressure Control Range psi	R1 174 to 1000 R2 203 to 2000 R3 232 to 3000 R4 232 to 3625	R1 174 to 1000 R2 203 to 2000 R3 232 to 3000 R4 232 to 3625	R1 174 to 1000 R2 203 to 2000 R3 232 to 3000 R4 232 to 3625
	Hysteresis %	3 max. (Note 2)	3 max. (Note 2)	3 max. (Note 2)
	Repeatability %	1	1	1
	Rated Current mA	800	800	800
	Coil Resistance Ω	20 (68°F)	20 (68°F)	20 (68°F)
Weight lbs		30.8	61.7	132

Note: 1.Indicates the pressure differential between the valve P port and A port.
2.Value when a Nachi-Fujikoshi special amplifier is used (with dithering).
3.These specifications apply to valves that include an electro-hydraulic proportional pilot relief valve (i.e. ESR-G06-250R2-11).
4.The maximum adjustment pressure is 3625 psi for a valve that does not include an electro-hydraulic proportional pilot relief valve.
Factory default is minimum output (507 psi max.) Set this value in accordance with the pressure of the hydraulic circuit being used.

Understanding Model Numbers

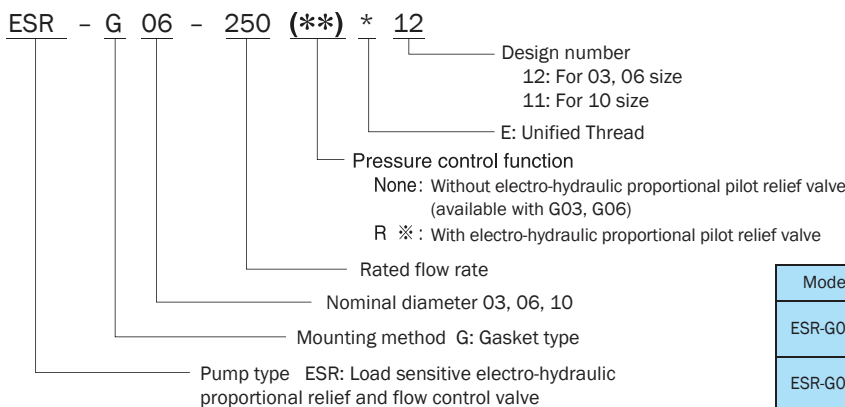

Model No.	Bolt Size	Q'ty	Tightening Torque ft lbs
ESR-G03	3/8-16 x 3 1/2	4	33 to 40
ESR-G06	5/8-11 x 5 1/4	4	140 to 173
ESR-G10	3/4-10 x 5	4	272 to 339

- 8 Sub Plate
See the next page for more information about sub plates.
- 9 Use an operating fluid that conforms to the both of the following. Oil temperature: -4 to 158°F
Viscosity: 12 to 400 centistokes. The recommended viscosity range is 15 to 60 centistokes.

10 Since this valve has a built-in pressure compensation valve, changing of the inertial load (using a high inertial oil motor, etc.) can create the risk of hunching under certain conditions. Contact your sales agent before changing the inertial load.

Installation Dimension Drawings

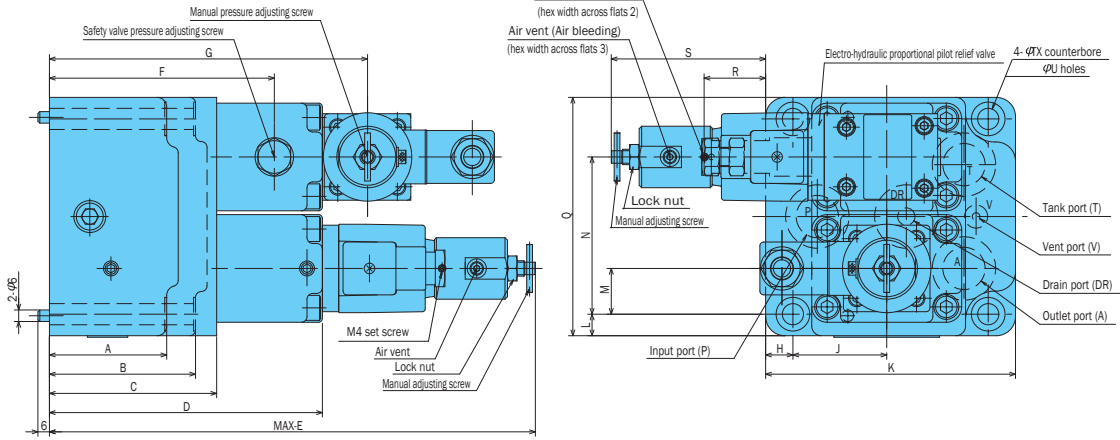

Model No.	A	B	C	D	E	F	G	H	J	K	L	M	N	Q	R	S	T	U
ESR-G03	61	76	87	142	252.8	117	165.5	14.2	48.8	130	11.2	23.8	81.8	124	32	80.3	17.5	11
ESR-G06	76	110	120	172	282.8	154	195.5	16.8	57.2	167	17	28	118	180	21	68.3	26	18
ESR-G10	107	107	150	205	317.3	183	228.5	25	76	228	23.5	35	162	244	-3	35.3	32	22

Sub Plate
MSR-03*-E10

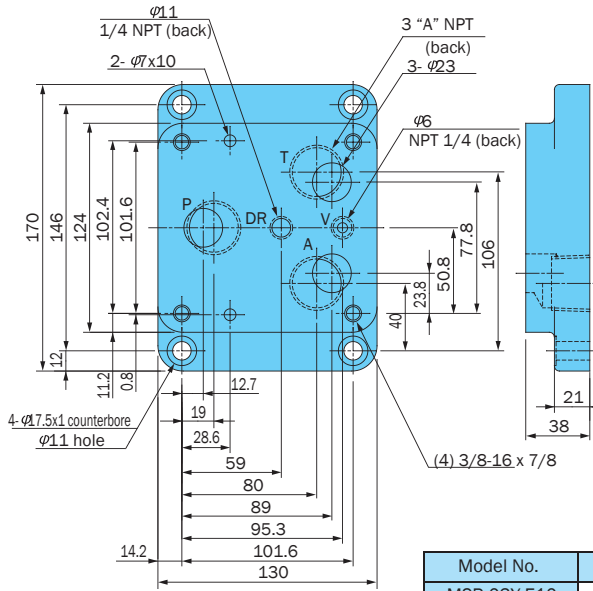

Model No.	A NPT
MSR-03Y-E10	3/4
MSR-03Z-E10	1

MSR-06*-E10

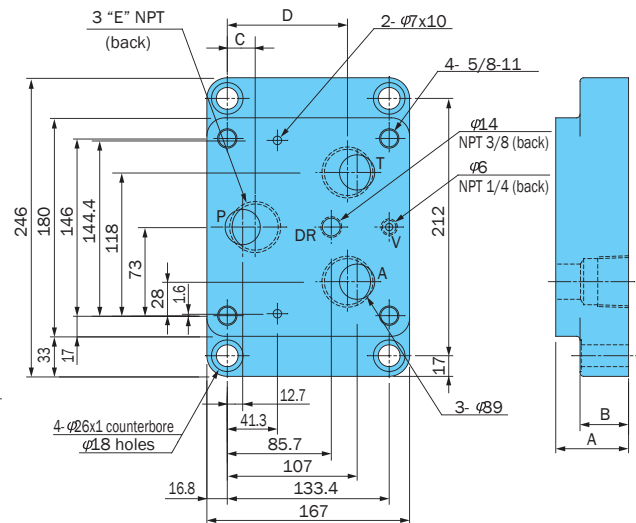

Model No.	A	B	C	D	E
MSR-06X-E10	95	25	16	107	1 NPT
MSR-06Y-E10	60	40	23	99	1 1/4 NPT

ESR-G10 Mounting Gasket Surface
Dimensions

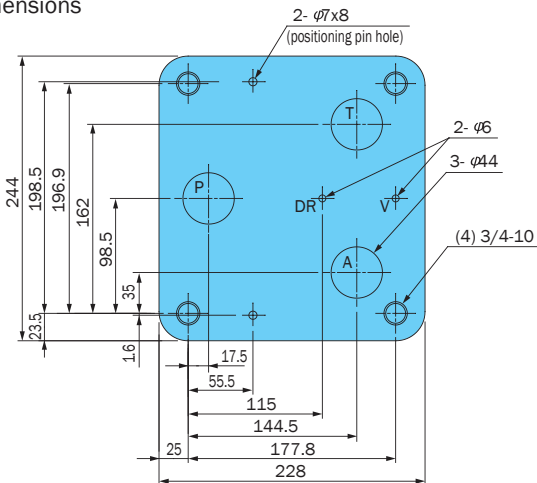

The gasket surface dimensions comply with the ISO standards shown below.
ESR-G03-ISO 6263-07-11-97
ESR-G06-ISO 6263-08-15-97

Performance Curves

Hydraulic Operating Fluid Viscosity 32 centistokes

Input Current – Flow Rate Characteristics

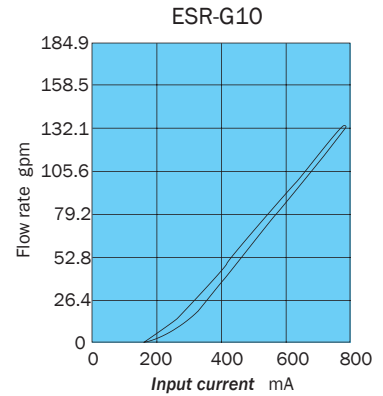
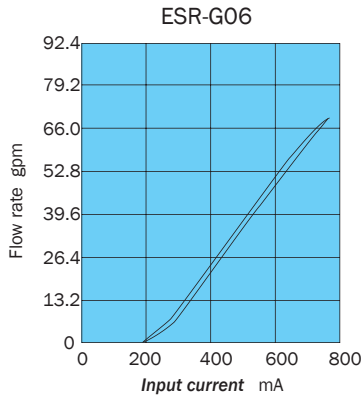
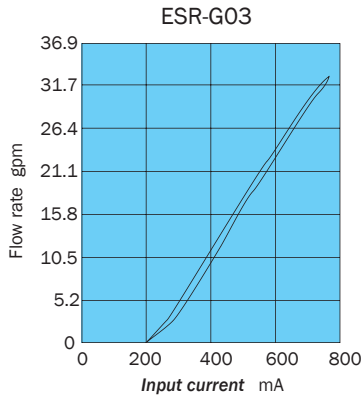

Fluid Temperature – Control Flow Rate Characteristics

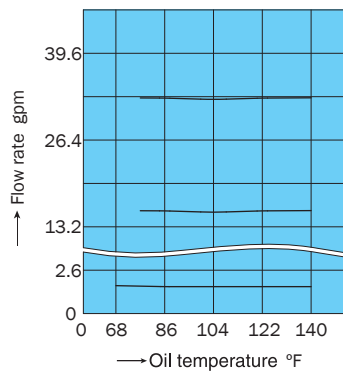

Load Pressure: 1450 psi
Operating Fluid: VG32
Value when a Nachi-Fujikoshi special amplifier is used (with dithering).

Pressure – Control Flow Rate Characteristics

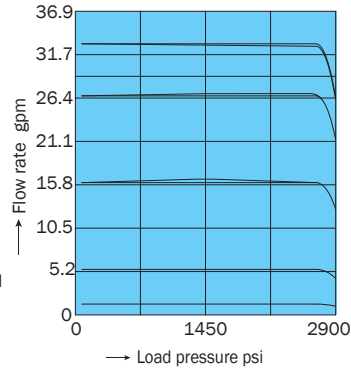

Electro-hydraulic Proportional Pilot
Relief Valve Setting Pressure 3045 psi
Operating Fluid: VG32
Fluid Temperature: 104° F
Value when a Nachi-Fujikoshi special amplifier is used (with dithering).

Cross-sectional Drawing

ESR-G***-11, 12

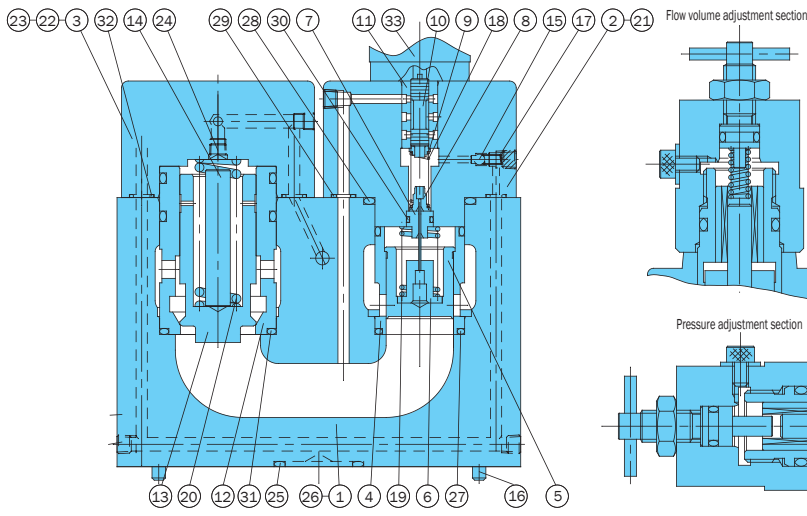

Part No.	Part Name	Part No.	Part Name
1	Body	18	Spring
2	Cover (A)	19	Spring
3	Cover (B)	20	Spring
4	Sleeve	21	Screw
5	Spool	22	Screw
6	Guide	23	Safety valve
7	Sleeve	24	Choke
8	Retainer	25	O-ring
9	Retainer	26	O-ring
10	Piston	27	O-ring
11	Sleeve	28	O-ring
12	Sleeve	29	O-ring
13	Poppet	30	O-ring
14	Guide	31	O-ring
15	Ball	32	O-ring
16	Pin	33	Proportional solenoid
17	Spring		

Note: Coil model number JD64-D2

List of Sealing Parts

Part No.	Part Name	ESR-G03		ESR-G06		ESR-G10	
		Part Number	Q'ty	Part Number	Q'ty	Part Number	Q'ty
25	O-ring	1B-P26	4	1B-G35	4	1B-P48	4
26	O-ring	1B-P9	1	1B-P9	1	1B-P9	1
27	O-ring	1B-G25	2	1B-G35	2	1B-G50	2
28	O-ring	1B-G35	1	1B-G45	1	1B-G60	1
29	O-ring	1B-P6	3	1B-P8	3	1B-P9	3
30	O-ring	1B-P9	1	1B-P9	1	1B-P9	1
31	O-ring	1B-G35	3	1B-P46	3	1B-G65	3
32	O-ring	1B-P6	2	1B-P8	2	1B-P9	2
Seal Kit Number		JLS-G03R		JLS-G06R		JLS-G10R	

Note: 1.O-ring 1B-** refers to JIS B2401-1B-**. 2.EPR-G01 seal is available separately. See page G-3 for more information.



Proportional Valves